

PRODUCT CATALOG

BENEFITING SOCIETY THROUGH **INSPIRED** INNOVATIONS



INSPIRED PLASTIC INJECTION

→ 1954

Founded by Mr. André CORADIN

→ 1998

Acquired by PENTAPHARM

→ 2003

New site built in Mouans-Sartoux

→ 2018

Florence BIDAMANT and Fabrice BOURDIER, majority shareholders; Caspar STÜRM becomes Chairman of the Supervisory Board

→ 1954

Fondation par M. André CORADIN

→ 1998

Acquisition par PENTAPHARM

→ 2003

Nouveau site construit à Mouans-Sartoux

→ 2018

Florence BIDAMANT et Fabrice BOURDIER deviennent actionnaires majoritaires; Caspar STÜRM préside le Conseil de Surveillance



INNOVATION - PERFORMANCE - QUALITY - PROXIMITY

INNOVATION - PERFORMANCE - QUALITÉ - PROXIMITÉ

Back to 1998 when CORADIN was acquired by PENTAPHARM, the Swiss Group had the vision to serve the cosmetic, pharmaceutical and diagnostic markets through **performance and innovation** in the field of injection molding.

Today, totally independent and privately owned, CORADIN is recognized as an **innovative solutions provider** that makes **quality** and **proximity to its clients** the daily motto of the teams so that performance, service and reliability be continuously delivered to their customers in the **Hygiene and Beauty**, as well as **Health** Industries.

En 1998, lors de l'acquisition de CORADIN par PENTAPHARM, le groupe suisse avait pour vision de servir les marchés de la cosmétique, de la pharmacie et du diagnostic par **la performance et l'innovation** dans le domaine du moulage par injection.

Aujourd'hui, avec un actionariat totalement indépendant et privé, CORADIN est reconnue comme un **fournisseur de solutions innovantes** qui fait de la **qualité** et de la **proximité avec ses clients** la devise quotidienne des équipes afin que performance, service et fiabilité soient sans cesse enregistrés par les acteurs **des secteurs de l'hygiène et de la beauté**, ainsi que de la **santé**.



CORPORATE SOCIAL RESPONSIBILITY AND SUSTAINABILITY

RESPONSABILITÉ SOCIÉTALE D'ENTREPRISE ET DURABILITÉ

CORADIN is a company that commits itself and acts every day so that its industrial activities are carried out in the respect of the People and the Environment.

CORADIN est une PME qui s'engage et agit chaque jour pour que ses activités industrielles soient menées dans le respect de l'Homme et de l'Environnement.

CORADIN's commitment to Corporate Social Responsibility and Sustainability is based on 3 major axes:

- SAFETY, HEALTH AND WELL-BEING AT WORK
- CODE OF CONDUCT AND ETHICS
- RESPECT FOR THE ENVIRONMENT AND SUSTAINABILITY

L'engagement de CORADIN dans la Responsabilité Sociétale d'Entreprise et la Durabilité s'articule autour de 3 axes majeurs :

- SÉCURITÉ, SANTÉ ET BIEN-ÊTRE AU TRAVAIL
- CODE DE CONDUITE ET ÉTHIQUE
- RESPECT DE L'ENVIRONNEMENT ET DURABILITÉ

Every day we take concrete actions to improve our working environment and the safety of employees in their workplace.

Chaque jour nous menons des actions concrètes pour améliorer notre environnement de travail et la sécurité des collaborateurs sur leur lieu de travail.

Each player in our company is responsible and the actions carried out are part of a good and ethical business and industrial practices framework.

It is the responsibility of each of us to limit our environmental impact but our company has set up a program for sorting and using of maximum industrial waste, by recycling materials and energy produced by our machines.



Chaque acteur de notre société est responsable et les actions menées s'inscrivent dans un cadre de bonne conduite et éthique des pratiques commerciales et industrielles.

Il est de la responsabilité de chacun d'entre nous de limiter notre impact environnemental mais notre société a mis en place un programme de tri et valorisation des déchets industriels, en pratiquant le recyclage des matières et de l'énergie produite par nos machines.

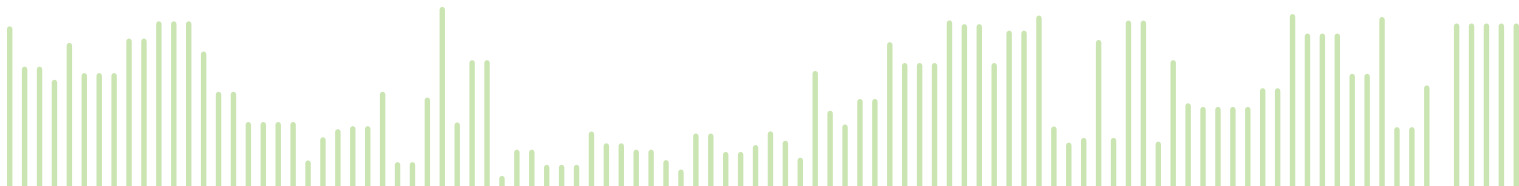

DESIGN & DEVELOPMENT

DESIGN & DÉVELOPPEMENT

Development of packagings and devices, from design to industrialization.

Registration of patents to protect our innovations and our clients.

Développement d'emballages et dispositifs, de la conception à l'industrialisation.

Enregistrement de brevets pour protéger nos innovations et nos clients.

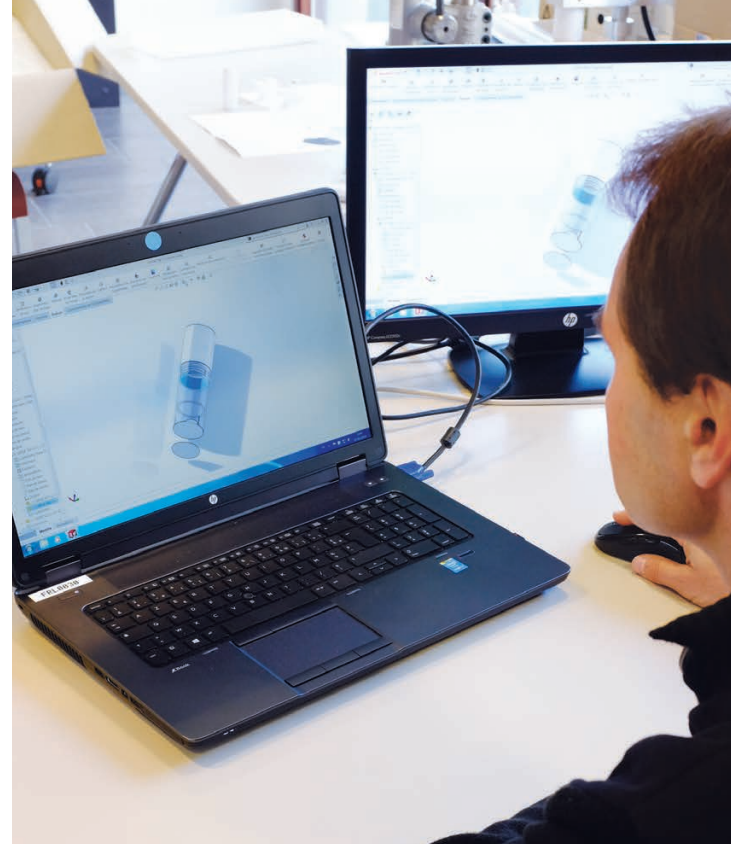

From a partner's or customer's brief, our research engineers and technicians carry out a feasibility study and suggest innovative solutions, together with external partners if needed.

Sur la base du brief d'un partenaire ou client, nos ingénieurs et techniciens en développement réalisent une étude de faisabilité et suggèrent des solutions innovantes, en collaboration avec des partenaires externes si besoin.

Strong and sustainable partnerships with our reliable manufacturers (European or local) of molds and industrial equipments, including prototyping and pilot lines.

Project management with a dedicated team at each step of your project.

Partenariats solides et durables avec nos fabricants (européens ou de proximité) de moules et d'équipements industriels, incluant les phases de prototypages et de lignes pilotes.

Gestion de projet avec une équipe dédiée à chaque étape de votre projet.





TECHNOLOGY

TECHNOLOGIES

- Injection of **one material or bi-injection molding**
- **Assembly** in the molds or according to dedicated processes
(manual, semi-automatic or automatic)
- **Blistering** of medical devices or specific parts
- **Hot sealing** of foils

- **Injection d'un matériau** ou moulage par **bi-injection**
- **Assemblage** dans les moules ou selon des processus dédiés
(manuel, semi-automatique ou automatique)
- **Mise sous blister** de dispositifs médicaux ou pièces spécifiques
- **Soudage** à chaud d'opercules

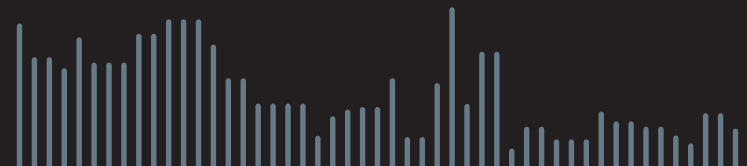

Doted of a 2500sqm workshop located in the South of France, CORADIN is manufacturing all products in clean room environment (ISO 5 and ISO 8, Class D).

CORADIN keeps investing in new industrial tools, and especially in the injection of multi materials. The park of exclusively electrical presses is carefully monitored to insure perfect process traceability.



Doté d'un atelier de 2500 m² situé dans le sud de la France, CORADIN fabrique tous les produits en salle blanche (ISO 5 et ISO 8, classe D).

CORADIN continue d'investir dans de nouveaux outils industriels, notamment dans l'injection de matériaux multiples. Le parc de presses exclusivement électriques est soigneusement contrôlé pour assurer une parfaite traçabilité des procédés.



KNOW-HOW & QUALIFICATION

KNOW-HOW & QUALIFICATION

From the design to the product industrialization, CORADIN offers high expertise in product qualification (DQ, IQ, OQ, PQ) of plastic injected parts.

De la conception à l'industrialisation des produits, CORADIN offre une grande expertise dans la qualification de pièces injectées (QD, QI, QO, QP).

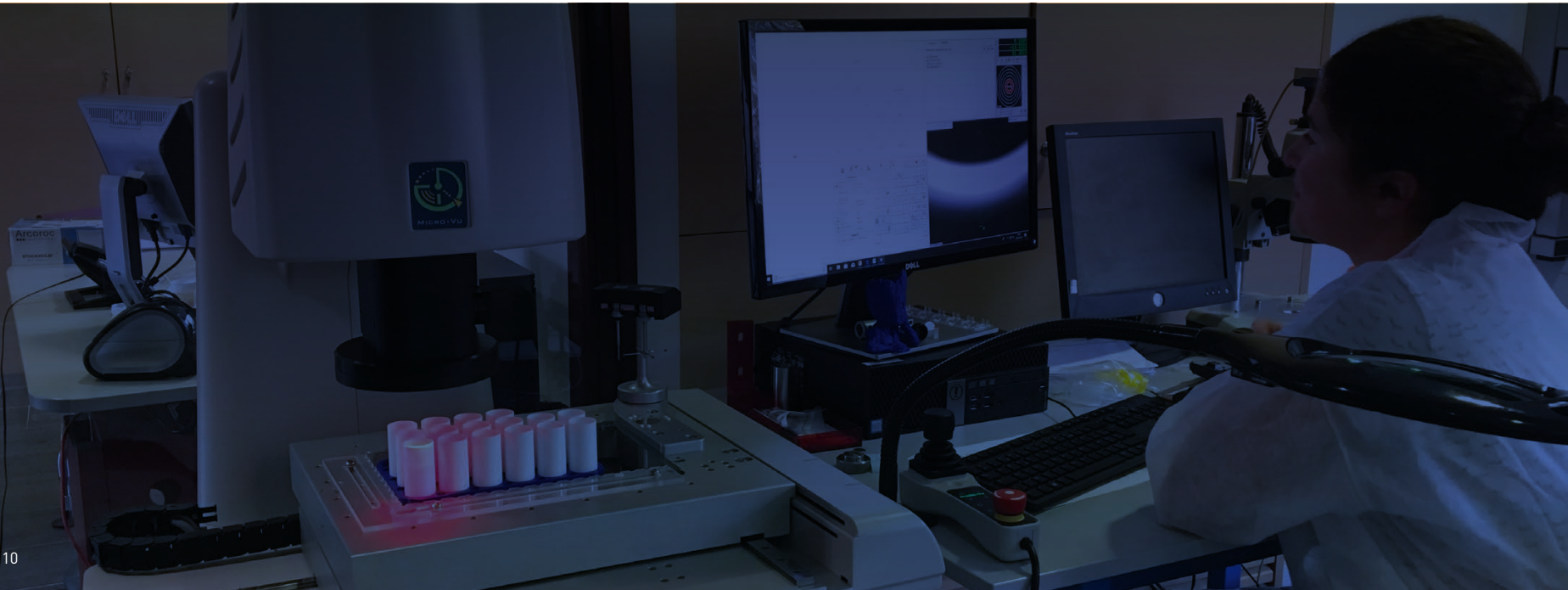
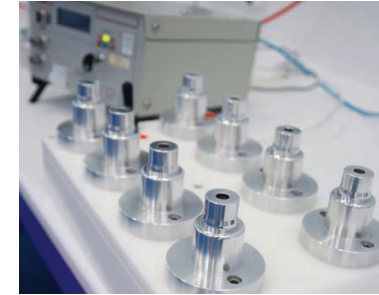

QUALITY

QUALITÉ

The Quality Department is key in our organization. It is in charge of regular controls in production but monitors as well the quality from the raw materials until the final release of the products.

The laboratory is toolled up with pressure equipment, vacuum chamber, oven, ATEQ machine, microscope, 3D optical measuring equipment MicroVu, ...

Le Département Qualité est un pilier de notre organisation. Il est chargé des contrôles réguliers de la production mais contrôle aussi la qualité des matières premières jusqu'à la libération finale des produits.

Le laboratoire est équipé avec des équipements sous pression, cloche à vide, enceinte climatique, machine ATEQ, microscope, équipement de mesure optique 3D MicroVu, ...



Certifications

- ISO 9001 : 2015 (Quality management system)
- ISO 13485 : 2016 (Design and manufacturing of medical device)
- ISO 14001 : 2015 (Environmental standard)
- ISO 15378 : 2015 (Good Manufacturing Practice)

CE marking (MD Class I)

Agréments

- ISO 9001 : 2015 (Système de management de la Qualité)
- ISO 13485 : 2016 (Conception et fabrication de dispositifs médicaux)
- ISO 14001 : 2015 (Norme environnementale)
- ISO 15378 : 2015 (Bonnes Pratiques de Fabrication)

Marquage CE (DM de Classe I)

WE ARE COMMITTED TO HEALTH AND HYGIENE & BEAUTY

NOUS SERVONS LES MARCHÉS DE LA SANTÉ ET DE L'HYGIÈNE & BEAUTÉ

CORADIN is specialized in the design and development of standard solutions but proposes as well specific and exclusive technical parts. We continuously offer innovative packages and we have expertise for customized solutions.

CORADIN est spécialisée dans la conception et le développement de solutions standards, mais également de pièces techniques spécifiques et exclusives. Nous proposons en permanence des packages innovants et nous avons une expertise pour des solutions sur mesure.

Rooting back to its former Swiss mother company, the team has a wide experience – and somehow a part of its DNA – in the understanding of high challenging formulations, especially when it comes to mixing potent or active ingredients in the form of powder, liquid or freeze dried cakes, together with solvents.



En s'appuyant sur ses racines suisses, l'équipe possède une vaste expérience – et ceci fait désormais partie de son ADN – de la compréhension de formulations extrêmement complexes, notamment en ce qui concerne le mélange d'ingrédients actifs voire très sensibles sous forme de poudre, liquide ou lyophilisat.

**Innovation is part of our DNA and
we are continuously patenting novelties
that are linked to our expertise.**

**L'innovation fait partie de notre ADN
et nous déposons très régulièrement
des brevets liés à notre expertise.**



HYGIENE & BEAUTY

A dynamic splash of water with bubbles and droplets, rendered in shades of blue and white against a dark background, located on the right side of the slide.

DISPENSING
SYSTEMS

DUAL
SYSTEMS

AMPOULES

BOTTLES

CAPS
& CLOSURES

ACCESSORIES

A series of vertical bars of varying heights and colors (yellow, orange, red) located at the bottom right corner of the slide.

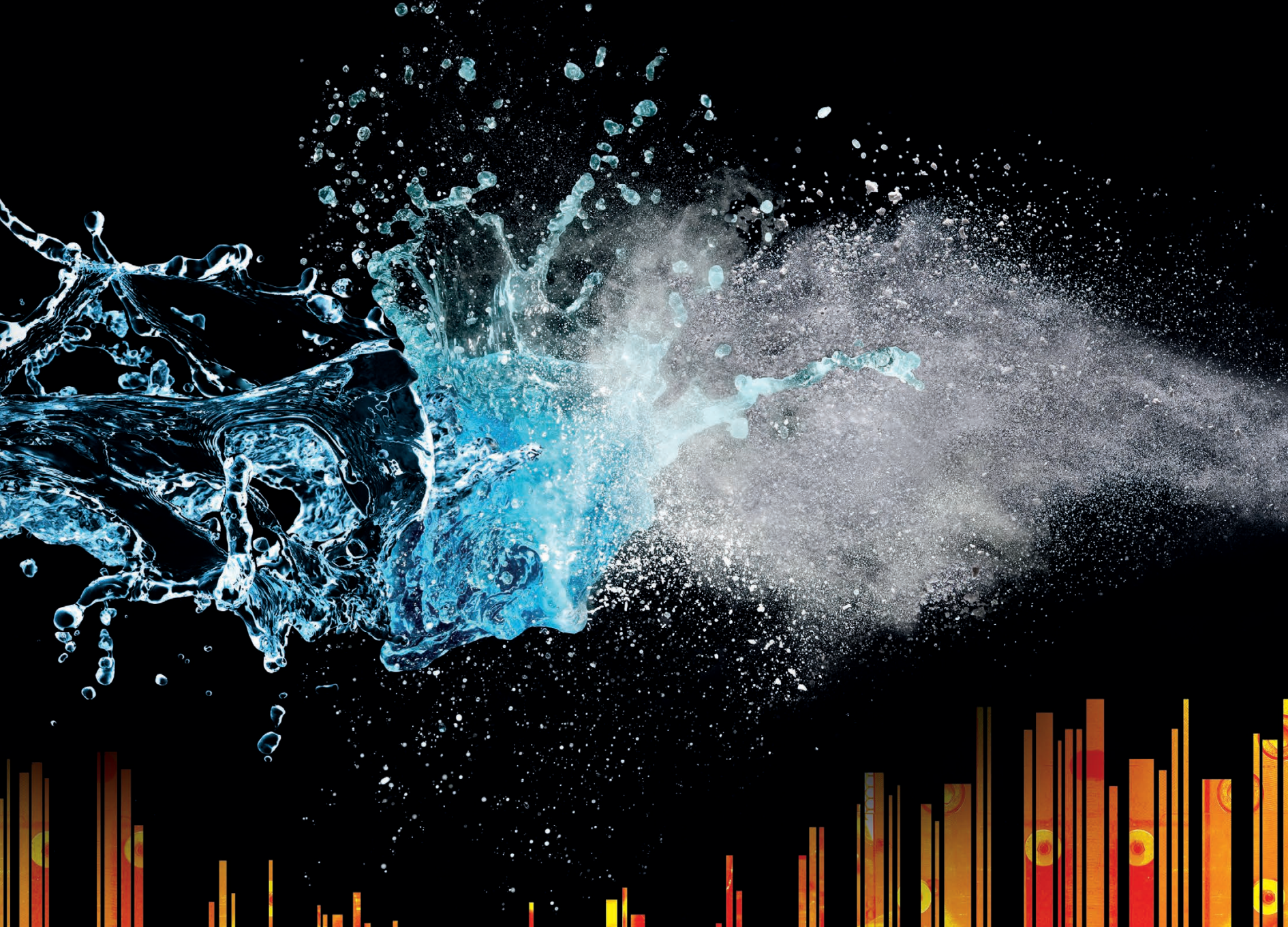

DISPENSING SYSTEMS



ECODIS® Dispenser

ECODIS® Dispenser is an innovative dispensing system in the ECODIS® line.

This cylindrical container with a supple base **combines a new way of applying cares with a fashionable aesthetic**. By simply pressing on the soft bottom part of the rigid barrel, the beauty care is applied on the skin.

ECODIS® Dispenser est un système de distribution innovant de la gamme ECODIS®.

Cet emballage cylindrique allie **une nouvelle façon d'appliquer des soins à une esthétique très tendance**. En appuyant simplement sur la partie inférieure du tube rigide, sur le fond souple, le soin de beauté est appliqué sur la peau.

MATERIALS | MATIÈRES

→ Barrel, Dropper and Cap in PP.
Tube, Stilligoutte et Coiffe de protection en PP.

→ Soft part to fill out the product in TPE*.
Partie flexible pour vidange surmoulée en TPE*.

* Thermo plastic elastomer / Thermoplastique élastomère.



Natural - White
Naturel - Blanc



Custom colors
Couleurs spécifiques



Metallizing
Métallisation



Spray painting
Laquage



Aluminium sleeve
Chape aluminium



Hot stamping
Marquage à chaud



Screen printing
Sérigraphie



Pad printing
Tampographie



Heat Transfer Labeling
Transfert d'image à chaud

Minimum Order Quantity (MOQ): 10 000 units / 5 000 units in natural or white

ECODIS® is a patented technology and registered trademark of CORADIN SAS. ECODIS® est une technologie brevetée et une marque déposée par CORADIN SAS



HOW TO USE | UTILISATION

1. Unscrew the cap.
Oter le capot en le dévissant.
2. Press softly the supple bottom to fill out the product.
Appuyer par petites pressions sur le fond souple pour distribuer le produit.

BENEFITS | AVANTAGES

- Design and innovative technology.
Design et technologie innovante.
- Patented.
Breveté.
- Easy to fill-in and assemble.
Facile à conditionner et à assembler.
- Easy to use packaging (very appreciated by the consumers).
Ludique et facile à utiliser (très apprécié par les consommateurs).
- Multi-solutions range for skin care, hair care, make-up, food products, ...
Multi-solutions pour les fabricants de soins (peau, capillaire, maquillage, ...), produits alimentaires, ...

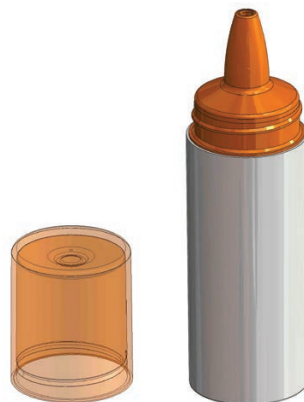

DISPENSING SYSTEMS



ECODIS® Flexy

ECODIS® Flexy is the new dispensing solution in the ECODIS® line allowing to select a wide choice of caps and closures, standard or specific.

By simply pressing on the soft bottom part of the rigid barrel, the beauty care is applied on the skin or in the hair.

ECODIS® Flexy est le nouveau système de distribution de la gamme ECODIS® offrant un large choix de bouchages associés, standards ou spécifiques.

En appuyant simplement sur la partie inférieure du tube rigide, sur le fond souple, le soin de beauté est appliqué sur la peau ou sur les cheveux.

MATERIALS | MATIÈRES

→ Barrel, Adapter in PP.

Tube, Adaptateur en PP.

→ Soft part to fill out the product in TPE*.

Partie flexible pour vidange surmoulée en TPE*.

* Thermo plastic elastomer / Thermoplastique élastomère.

PRODUCT NAME	CAPACITY	INDICATIVE WEIGHT
Barrel/Adapter GCM1 24/410 ECODIS® Flexy	10 ml	8.3 g
	15 ml	9.1 g
	30 ml	12.3 g
Barrel/Adapter CALIC® ECODIS® Flexy	10 ml	8.8 g
	15 ml	9.6 g
	30 ml	12.8 g



Natural - White
Naturel - Blanc



Custom colors
Couleurs spécifiques



Metallizing
Métallisation



Spray painting
Laquage



Hot stamping
Marquage à chaud



Screen printing
Sérigraphie



Pad printing
Tampographie



Heat Transfer Labeling
Transfert d'image à chaud

Minimum Order Quantity (MOQ): 10 000 units / 5 000 units in natural or white

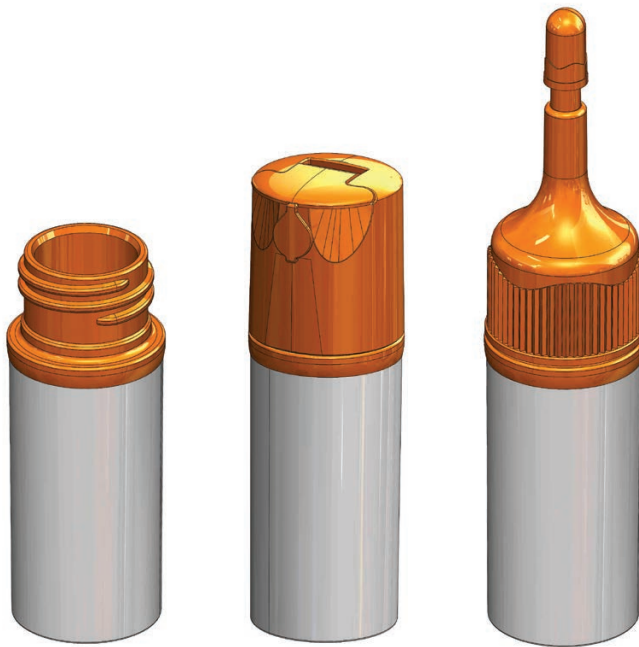

BENEFITS | AVANTAGES

- Design and innovative technology.
Design et technologie innovante.
- Flexible to adapt any specific dropper or standard cap.
Flexible pour ajouter un embout spécifique ou capsule standard.
- Patented.
Breveté.
- Easy to fill-in and assemble.
Facile à conditionner et à assembler.
- Easy to use packaging (very appreciated by the consumers).
Ludique et facile à utiliser (très apprécié par les consommateurs).
- Multi-solutions range for skin care, hair care, make-up, food products, ...
Multi-solutions pour les fabricants de soins (peau, capillaire, maquillage), produits alimentaires, ...

DISPENSING SYSTEMS



SERIDOSE®

Taking out the right dosage

... 1ml ... 2ml ... for skin!

Adjust colors for the right make-up foundation.
Smart dose of hair color, hair serum and more ...

Juste le bon dosage

... 1ml... 2ml... pour la peau!

Ajustez les couleurs pour un fond de teint parfait.
Dosage intelligent des couleurs pour les cheveux,
sérum capillaire et plus encore ...



PRODUCT NAME	PRODUCT CODE	COLOR	MATERIAL	CAPACITY	WEIGHT
Barrel SERIDOSE®	51052	White	PP	15ml	5.8 g
Cap/ Plug SERIDOSE®	70682	White/ White	PP/ PP	-	4.2 g
Syringe	40292	Natural/ White	PP/ PP	2ml	3.6 g

On request, SERIDOSE® can be manufactured in HDPE and/or 10ml, 30ml.

Sur demande, possibilité de commander SERIDOSE® en PEHD et/ou 10ml, 30ml.



Natural - White
Naturel - Blanc



Custom colors
Couleurs spécifiques



Metallizing
Métallisation



Spray painting
Laquage



Aluminium sleeve
Chape aluminium



Hot stamping
Marquage à chaud



Screen printing
Sérigraphie



Pad printing
Tampographie



Heat Transfer Labeling
Transfert d'image à chaud

Minimum Order Quantity (MOQ): 10 000 units

SERIDOSE® is a registered trademark of CORADIN SAS. SERIDOSE® est une marque déposée par CORADIN SAS.



BENEFITS | AVANTAGES

- Design and innovative technology.
Design et technologie innovante.
- Easy to fill-in and assemble.
Facile à conditionner et à assembler.
- Easy to use packaging and very precise dosage.
Ludique et dosage très précis.
- Multi-solutions range for skin care, hair care, make-up, ...
Multi-solutions pour les fabricants de soins de la peau, capillaire, maquillage, ...

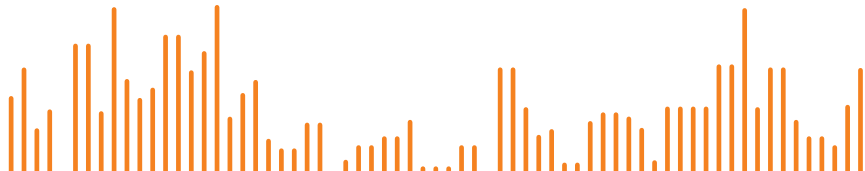

DISPENSING SYSTEMS



ECODIS® 2 in 1

The 2in1 version of the Dispensing system ECODIS® is simple and innovative. Consisting of a cartridge that is opened by simple pressure on the soft bottom, the powder or solution contained in the cartridge then mixes with the solution in the rigid tube. By simple pressure the care is drained from the bottle and applied on the skin or on the hair.

La version 2en1 du Dispenser ECODIS® est simple et innovante. Constituée d'une cartouche qui est percutee par simple pression du fond souple, la poudre ou solution contenue dans la cartouche se mélange alors à la solution présente dans le tube rigide. Par simple pression le soin est vidangé du flacon et appliqué sur la peau ou sur le cheveu.

MATERIALS | MATIÈRES

- Barrel, Dropper and Cap in PP.
Tube, Stilligoutte et Coiffe de protection en PP.
- Cartridge: PP overmolded with TPE*.
Volume: 3,5ml - Optimum volume estimated up to 2ml. Breakable aluminium foil.
Cartouche: PP surmoulé en TPE*.
Volume: 3,5ml - Volume de remplissage conseillé jusqu'à 2ml. Opercule cartouche 2en1 en aluminium percutable.

* Thermo plastic elastomer / Thermoplastique élastomère.

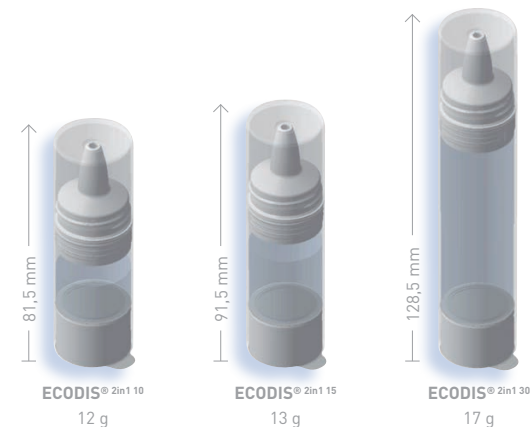

Natural - White
Naturel - Blanc



Custom colors
Couleurs spécifiques



Metallizing
Métallisation



Spray painting
Laquage



Aluminium sleeve
Chape aluminium



Hot stamping
Marquage à chaud



Screen printing
Sérigraphie



Pad printing
Tampographie



Heat Transfer Labeling
Transfert d'image à chaud

Minimum Order Quantity (MOQ): 10 000 units

ECODIS® is a patented technology and registered trademark of CORADIN SAS. ECODIS® est une technologie brevetée et une marque déposée par CORADIN SAS.

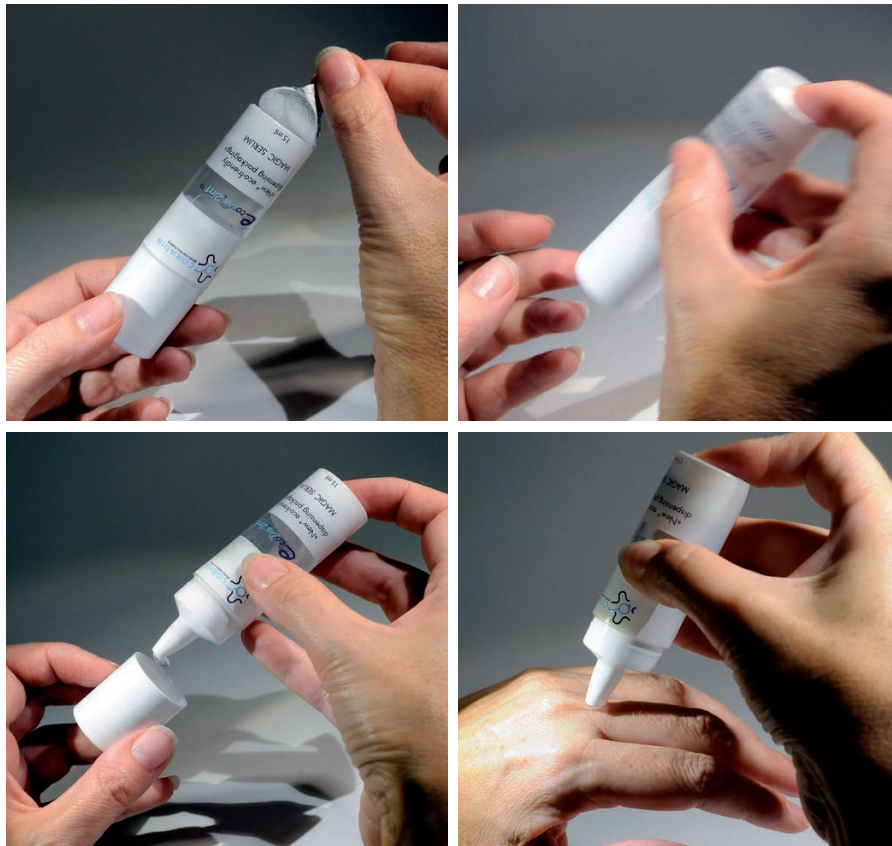

HOW TO USE | UTILISATION

1. Tear-off the aluminium foil.
Oter l'opercule alu.
2. Break the cartridge by pressing the soft bottom to fill out the powder/liquid.
Percuter la cartouche en appuyant sur le fond souple pour libérer la poudre ou le liquide.
3. Shake.
Agiter le produit.
4. Unscrew the cap.
Oter le capot en le dévissant.
5. Press softly the soft bottom to fill out the product.
Appuyer par petites pressions sur le fond souple pour distribuer le produit.

BENEFITS | AVANTAGES

- Design and innovative technology.
Design et technologie innovante.
- Patented.
Breveté.
- Easy to use packaging (very appreciated by the consumers).
Ludique et facile à utiliser (très apprécié par les consommateurs).
- Multi-solutions range for skin care, hair care, make-up, food products, ...
Multi-solutions pour les fabricants de soins (peau, capillaire, maquillage), produits alimentaires, ...

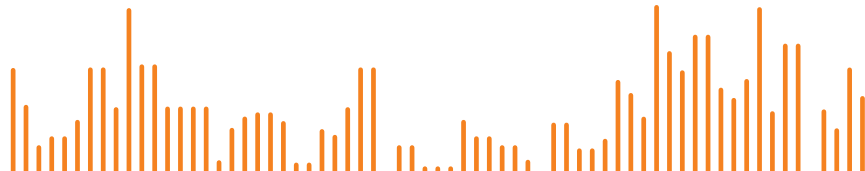

DUAL SYSTEMS



LUXURY VIALS SYSTEM®

For several decades, the cosmetic industry has been interested in the reconstitution of a formula from two compartmentalized steps. Freeze drying of active ingredients has been the principal means of compartmentalizing one of the steps. This type of procedure requires the use of two stoppered vials, one housing the lyophilisate or powder and a second with the solvent to dissolve the lyophilisate or powder. The consumer applies the product using the second vial. The LUXURY VIALS SYSTEM® is the most luxurious dual mixing system of the range of Vials.

Depuis plusieurs décennies, l'industrie cosmétique s'intéresse à la reconstitution d'une formule en deux phases compartimentées. La lyophilisation des principes actifs a été le principal moyen de compartimenter l'une des étapes. Ce type de procédure nécessite l'utilisation de deux flacons, l'un contenant le lyophilisat ou la poudre et l'autre le solvant pour dissoudre le lyophilisat ou la poudre. Le consommateur applique le produit à l'aide du deuxième flacon. LUXURY VIALS SYSTEM® est le système de mélange extemporané le plus luxueux de la gamme Vials.

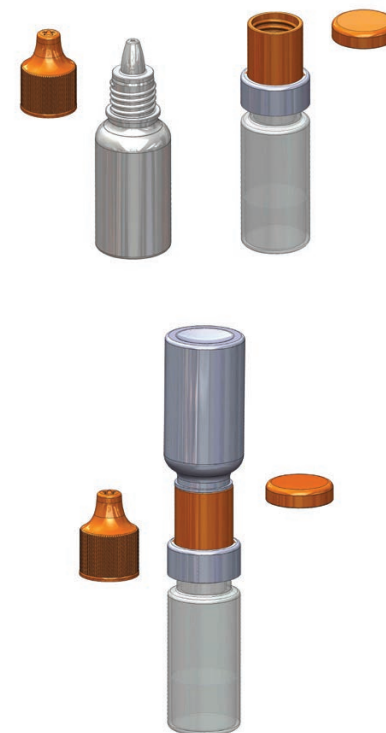

Natural - White
Naturel - Blanc



Custom colors
Couleurs spécifiques



Metallizing
Métallisation



Spray painting
Laquage



Hot stamping
Marquage à chaud



Screen printing
Sérigraphie



Pad printing
Tampographie

Minimum Order Quantity (MOQ): 10 000 units

LUXURY VIALS SYSTEM® is a registered trademark of CORADIN SAS. LUXURY VIALS SYSTEM® est une marque déposée par CORADIN SAS.

PRODUCT NAME	PRODUCT CODE	COLOR	MATERIAL	CAPACITY	INDICATIVE WEIGHT
Vial LUXURY	40052	Clear	Glass	10 ml	9.9 g
Rubber Stopper/Foil LUXURY	70282	White with alu	TPE/ALU	-	1.4 g
Connecting Ring LUXURY	50557 50981 50982	Natural White Black	HDPE HDPE HDPE	-	1.5 g
Ring LUXURY	40186 40268	Matt Shiny	ALU ALU	-	0.57 g
Protective Cap LUXURY	50150 50151 50984	Natural White Black	LDPE LDPE LDPE	-	0.46g
Nozzle LUXURY	50543 50983	Natural White	PP PP	-	0.62 g
Cap LUXURY Screw	50443 50677	White Black	PP PP	-	1.15 g
Bottle CORALIGNE®	40192	Natural	LDPE	7ml	2.5 g
	40230	White	LDPE	7ml	
	40103	Natural	MDPE	7ml	
	40111	White	MDPE	7ml	
	40245	Natural	LDPE	12ml	2.9 g
	40246	White	LDPE	12ml	
	40102	Natural	MDPE	12ml	
	40110	White	MDPE	12ml	

HOW TO USE | UTILISATION

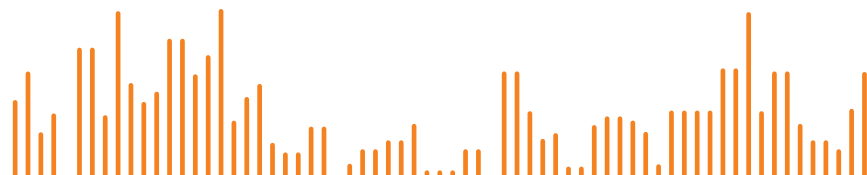
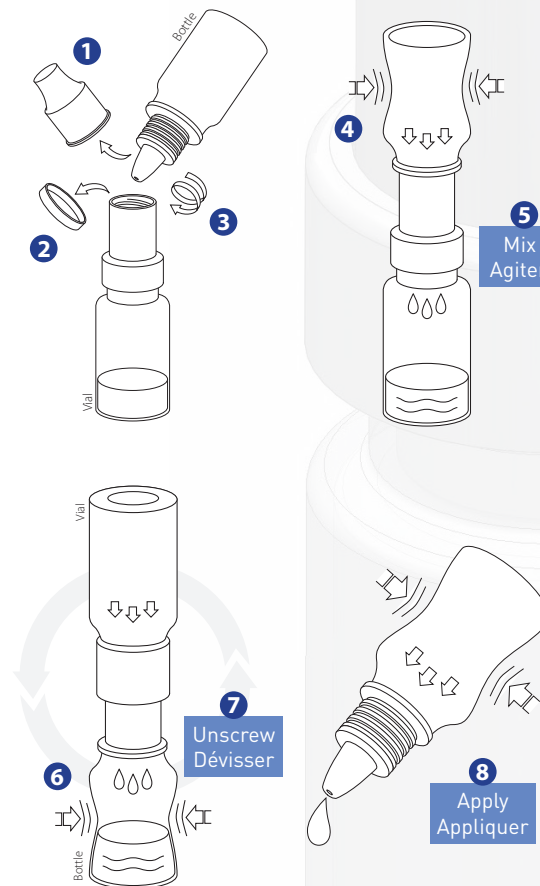

DUAL SYSTEMS



PRIMARY VIALS SYSTEM®

Product reconstitution in the PRIMARY VIALS SYSTEM® adds a technical nature to the product. Including an external mixing stage confers to the product a preciousness, richness and above all an idea of assured effectiveness. Compartmentalization allows for the use of relatively unstable raw materials susceptible to oxidation.

La reconstitution du produit dans le PRIMARY VIALS SYSTEM® ajoute une touche de technicité au produit. L'idée de disposer d'une phase externe à mélanger de manière extemporanée confère au produit un côté précieux, riche et surtout une efficacité certaine. La compartimentation permet de travailler des matières premières plutôt instables et sensibles à l'oxydation.

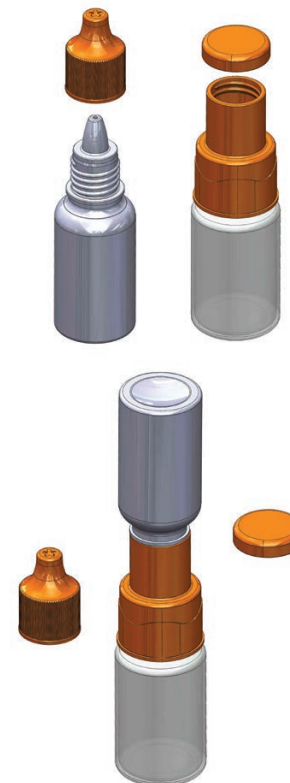

Natural - White
Naturel - Blanc



Custom colors
Couleurs spécifiques



Metallizing
Métallisation



Spray painting
Laquage



Hot stamping
Marquage à chaud



Screen printing
Sérigraphie



Pad printing
Tampographie

Minimum Order Quantity (MOQ): 10 000 units

PRIMARY VIALS SYSTEM® is a registered trademark of CORADIN SAS. PRIMARY VIALS SYSTEM® est une marque déposée par CORADIN SAS.

PRODUCT NAME	PRODUCT CODE	COLOR	MATERIAL	CAPACITY	INDICATIVE WEIGHT	
Vial PRIMARY	40046	Clear	Glass	12ml	15.45g	
Rubber Stopper/Foil PRIMARY	70282	White with alu	TPE/ALU	-	1.4g	
Snap Ring PRIMARY	50622	White	HDPE		3.15g	
Protective Cap PRIMARY	50249 50706	Natural White	PP		0.5g	
Nozzle CORALIGNE®	50073 50651	Natural White	LDPE		0.65g	
Cap CORALIGNE® Screw	50438 50317	Natural White	PP		1.15g	
Bottle CORALIGNE®	40192	Natural	LDPE		7ml	2.5g
	40230	White	LDPE	7ml		
	40103	Natural	MDPE	7ml		
	40111	White	MDPE	7ml		
	Bottle CORALIGNE®	40245	Natural	LDPE	12ml	2.9g
		40246	White	LDPE	12ml	
		40102	Natural	MDPE	12ml	
		40110	White	MDPE	12ml	

HOW TO USE | UTILISATION

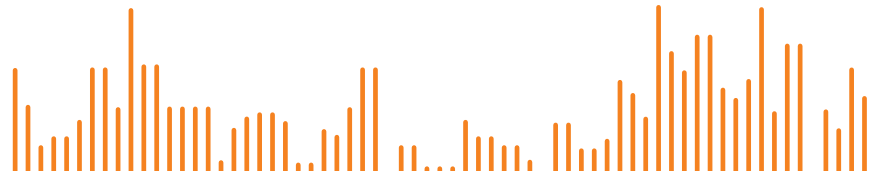
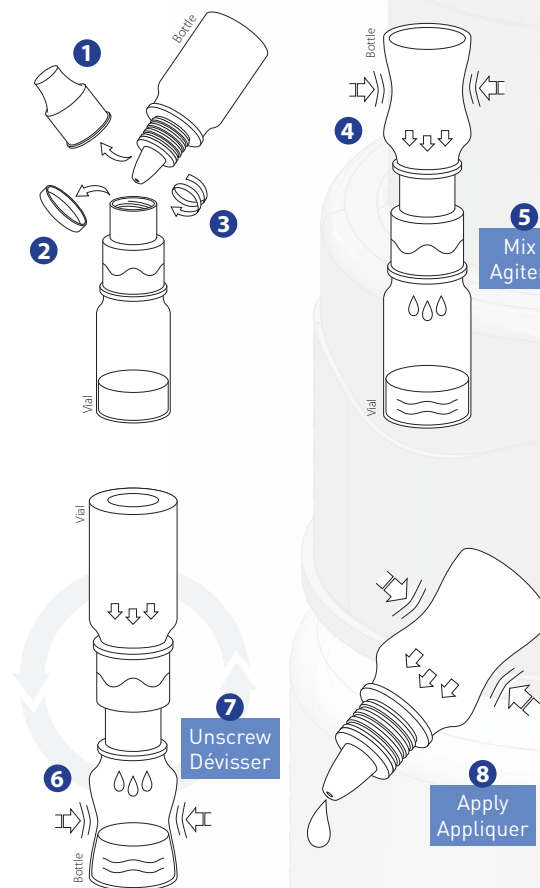

DUAL SYSTEMS



EASY VIALS®

The EASY VIALS® are easy to use and enjoyable. They enable the reconstitution of two liquid ingredients. They aim at on-the-go and attention grabbing applications.

Le système EASY VIALS® est facile à utiliser et ludique. Il permet la reconstitution de deux phases liquides. Il est destiné à des applications nomades ou coups d'éclat.

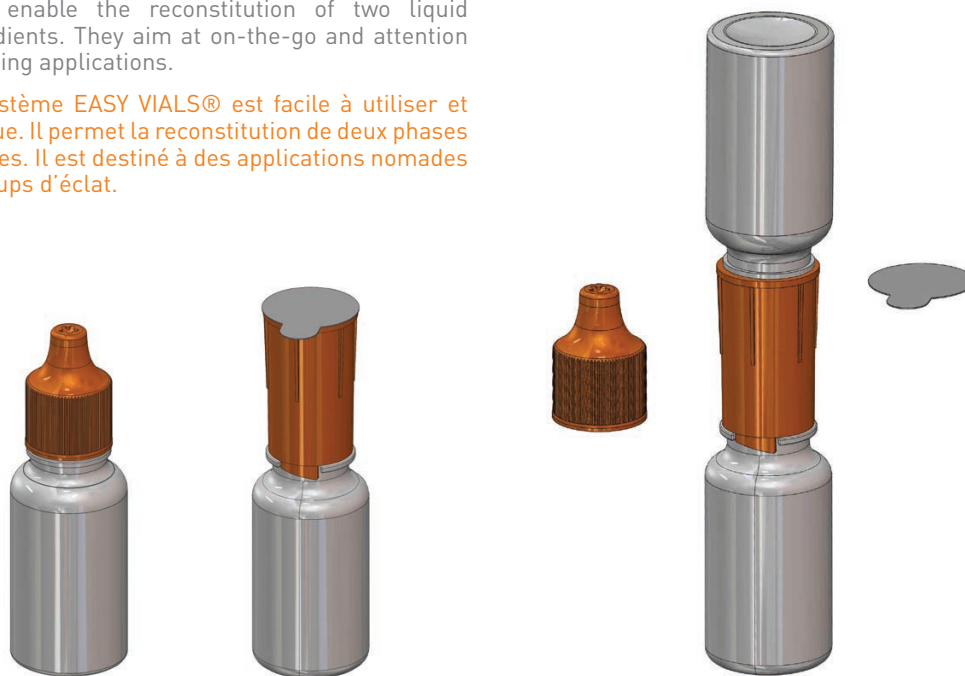

Natural - White
Naturel - Blanc



Custom colors
Couleurs spécifiques



Metallizing
Métallisation



Spray painting
Laquage



Hot stamping
Marquage à chaud



Screen printing
Sérigraphie



Pad printing
Tampographie

Minimum Order Quantity (MOQ): 10 000 units

EASY VIALS® is a registered trademark of CORADIN SAS. EASY VIALS® est une marque déposée par CORADIN SAS.

PRODUCT NAME	COLOR	MATERIAL	CAPACITY	INDICATIVE WEIGHT
Connecting Ring EASY	White	HDPE	-	2.35g
Nozzle CORALIGNE®	Natural White	LDPE LDPE		0.65g
Cap EASY Screw	Natural White	PP		1.15g
Bottle EASY	Natural White	LDPE MDPE	7 ml 12 ml	2.55g 2.95g

HOW TO USE | UTILISATION

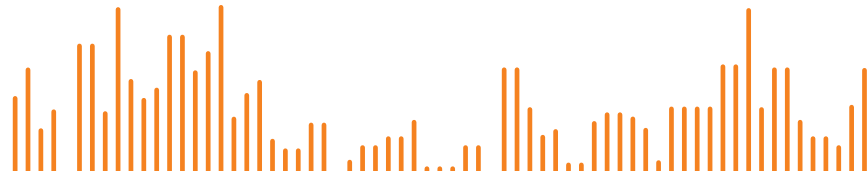
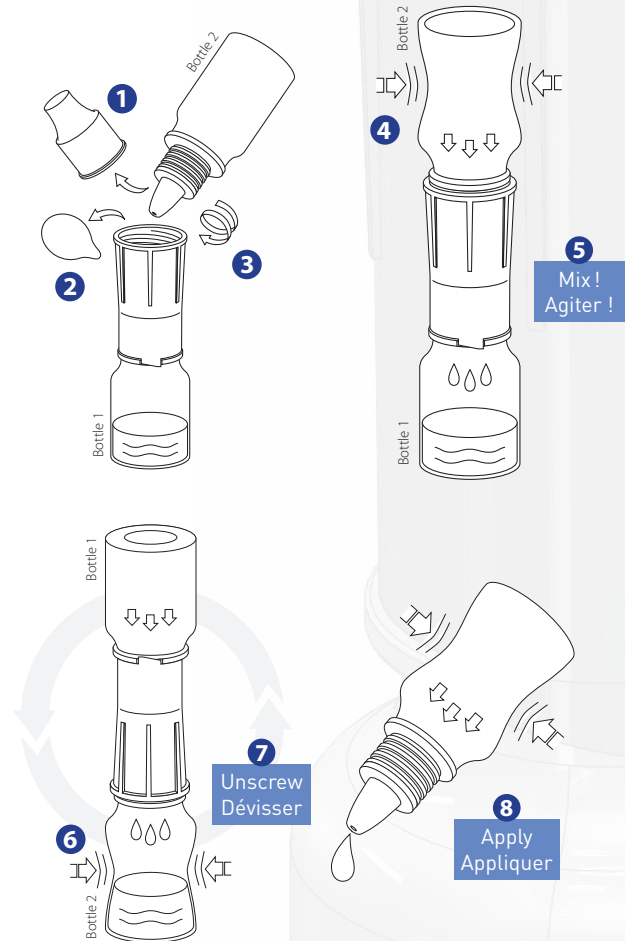

AMPOULES

CORADOSE®

CORADOSE® is a plastic ampoule, closed by a repositionable stopper, with safety assured by a tamper evident ring.

CORADOSE® is a simple and efficient single-dose solution, an excellent alternative to breakable glass vials.

CORADOSE® est une ampoule plastique, fiable grâce à sa bague d'inviolabilité, et qui est fermée par un bouchon repositionnable.

Excellente alternative aux ampoules verre cassantes et coupantes. CORADOSE® est une solution mono-dose simple et efficace.



PRODUCT NAME	PRODUCT CODE	COLOR	NECK	MATERIAL	CAPACITY	WEIGHT
Barrel CORADOSE® Beauty	50879	Natural	19.45mm	PP	10ml	3.2 g
Cap CORADOSE® Beauty	50878	White	-	LDPE	-	1.1 g



Natural - White
Naturel - Blanc



Custom colors
Couleurs spécifiques



Hot stamping
Marquage à chaud



Screen printing
Sérigraphie

Minimum Order Quantity (MOQ): 10 000 units

CORADOSE® is a registered trademark of CORADIN SAS. CORADOSE® est une marque déposée de CORADIN SAS.

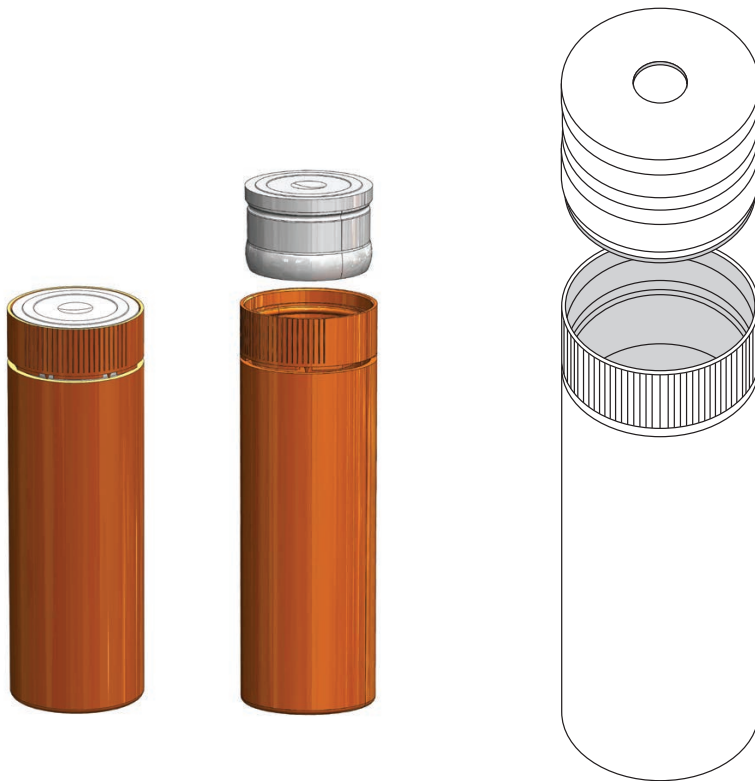

BENEFITS | AVANTAGES

- Unbreakable.
Incassable.
- Easy transport.
Nomade.
- Easy opening.
Ouverture facile.

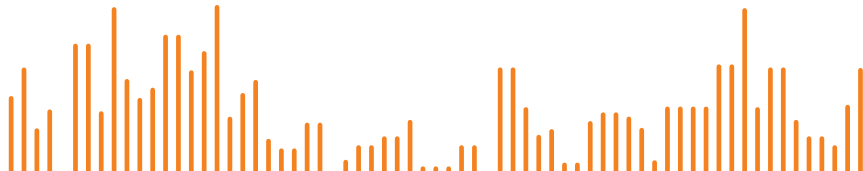

BOTTLES



CORALIGNE®

The 3ml, 7ml, 12ml, and 20ml CORALIGNE® bottles are cosmetic packaging.

Cylindrical in form, these bottles allow a simple and precise dispensing of the product.

Les flacons CORALIGNE®, disponibles en 3ml, 7ml, 12ml et 20ml sont des emballages cosmétiques.

De forme cylindrique, ces flacons permettent une distribution simple et précise du produit.

PRODUCT NAME	PRODUCT CODE	COLOR	MATERIAL	CAPACITY	WEIGHT	
Bottle CORALIGNE® Beauty	40233 40235	Natural White	LDPE	3ml	1.6g	
	40192 40230 40103 40111	Natural White Natural White	LDPE	7ml	2.5g	
			MDPE			
	40245 40246 40102 40110	Natural White Natural White	LDPE	12ml	2.9g	
			MDPE			
	40234 40236	Natural White	LDPE	20ml	4.5g	
	Nozzle CORALIGNE® Beauty	50073 50651	Natural White	LDPE	-	0.65g
	Cap CORALIGNE® Beauty Screw	50317	White	PP	-	1.15g



Natural - White
Naturel - Blanc



Custom colors
Couleurs spécifiques



Metallizing
Métallisation



Spray painting
Laquage



Hot stamping
Marquage à chaud



Screen printing
Sérigraphie



Pad printing
Tampographie



Heat Transfer Labeling
Transfert d'image à chaud

Minimum Order Quantity (MOQ): 10 000 units

CORALIGNE® is a registered trademark of CORADIN SAS. CORALIGNE® est une marque déposée par CORADIN SAS.

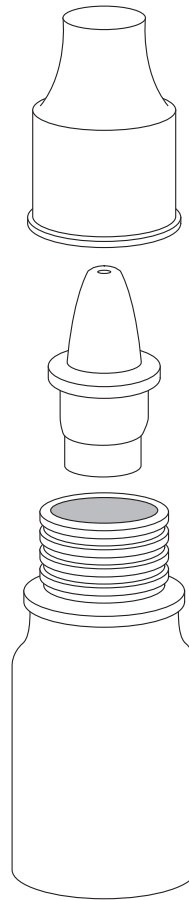
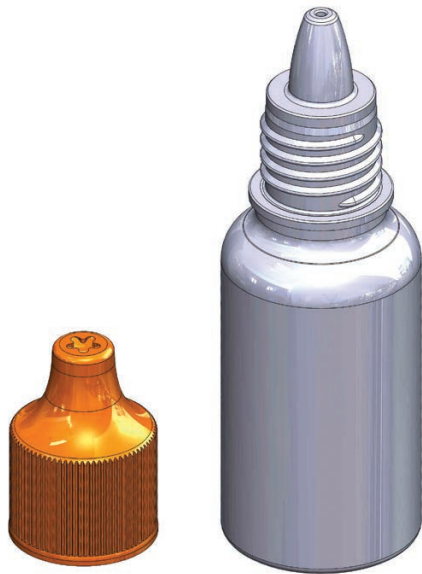

BENEFITS | AVANTAGES

- Unbreakable.
Incassable.
- Easy transport.
Nomade.
- Easy opening and closing.
Ouverture et fermeture facile.
- Decoration and colors on request.
Décors et couleurs à façon.

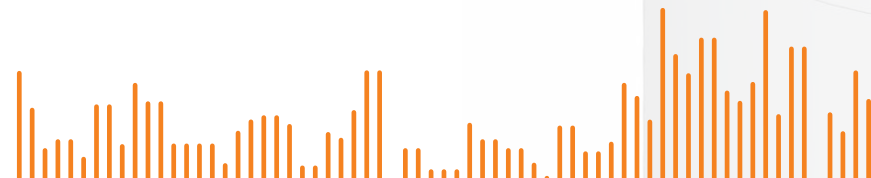
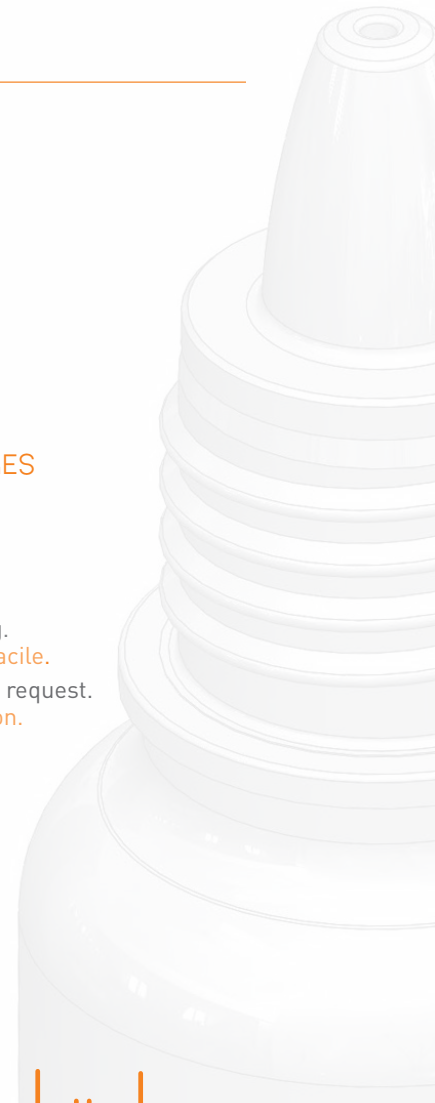

BOTTLES



TIM & SAM

New range of TIM bottles made in PET (standard neck) and SAM bottles (for CALIC® cap) made in HDPE !

Nouvelle gamme de flacons TIM en PET (col standard à visser) et flacons SAM en PEHD (pour capsule CALIC®) !



PRODUCT NAME	COLOR	NECK	MATERIAL	CAPACITY	WEIGHT
Bottle TIM Beauty 100ml	Natural White Black Amber	24mm	PET	100ml	15g
Bottle TIM Beauty 150ml			PET	150ml	19g
Bottle TIM Beauty 200ml			PET	200ml	21g
Bottle TIM Beauty 250ml			PET	250ml	23g
Bottle SAM Beauty 200ml	Black White		PE	200ml	20g
Bottle SAM Beauty 250ml	Black White		PE	250ml	23g



Hot stamping
Marquage à chaud



Screen printing
Sérigraphie

Minimum Order Quantity (MOQ): 10 000 units

CAPS & CLOSURES



PAC

Our 24/410 cuttable tip is available in an assortment of colors and can be metalized.

Screwed to the bottle, it enables the precise application of cosmetic products (for example care products or antiparasitic hair products).

Notre pointe à couper 24/410 est disponible en différents coloris et peut être métallisée.

Vissée sur un flacon, elle permet la distribution ciblée de produits cosmétiques (soins ou antiparasitaires capillaires par exemple).



PRODUCT NAME	PRODUCT CODE	NECK	MATERIAL	COLOR	WEIGHT
Cap/Cuttable Tip PAC 24/410 Screw	70019	GCMI 24/410	LDPE/ LDPE	White	3.2g



Natural - White
Naturel - Blanc



Custom colors
Couleurs spécifiques



Metallizing
Métallisation

Minimum Order Quantity (MOQ): 10 000 units

CAPS & CLOSURES

CALIC®

CALIC® is a single unit snap-on cap, click-fit, tamper evident (protected by a tear away plastic pellet).

La capsule CALIC® est une capsule monobloc, encliquetable, à levier inviolable (protection par une pastille déchirable).

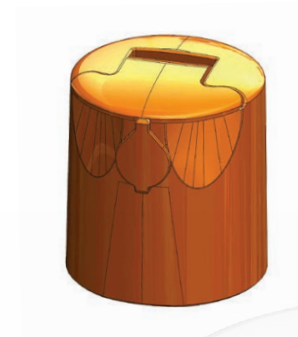

PRODUCT NAME	PRODUCT CODE	MATERIAL	COLOR	ORIFICE DIAMETER	NECK	MOQ
Cap CALIC® Snap-on	50457	HDPE	White	Ø 1.5mm (1.7mm²)	27.5mm	24 000 u.
	50688		Natural	Ø 1.5mm (1.7mm²)		24 000 u.
	50687		Blue	Ø 1.5mm (1.7mm²)		48 000 u.
	51025		Natural	Ø 3mm (7mm²)		
	50704		White	Ø 3mm (7mm²)		
	50807		Black	Ø 3mm (7mm²)		



Natural - White
Naturel - Blanc





Custom colors
Couleurs spécifiques

ACCESSORIES

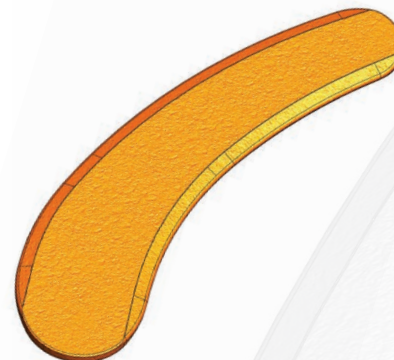

CLOE



PRODUCT NAME	PRODUCT CODE	MATERIAL	COLOR	INDICATIVE LENGTH	INDICATIVE WIDTH	INDICATIVE WEIGHT
Spatula CLOE	50047	PS	Natural	62.2mm	1.5mm	1.1g
	50048	PS	White			
	50811	PS	Black			
	50584	PP	Natural	61.5mm	1.5mm	0.9g
	50703	PP	White			
	50481	LDPE	Natural	60.8mm	1.5mm	1g
	50903	LDPE	White			
	50245	HDPE	Natural			
 Spatula CLOE-R	51079	recycled PP	Black	61.5mm	1.5mm	0.9g



Natural - White
Naturel - Blanc



Custom colors
Couleurs spécifiques



Hot stamping
Marquage à chaud



Pad printing
Tampographie

Minimum Order Quantity (MOQ): 10 000 units

ACCESSORIES



MARGOT

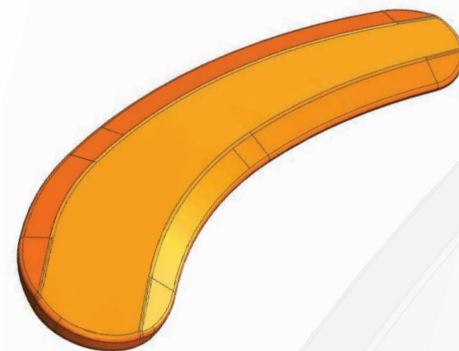

PRODUCT NAME	PRODUCT CODE	MATERIAL	COLOR	INDICATIVE LENGTH	INDICATIVE WIDTH	INDICATIVE WEIGHT	MOQ
Spatula MARGOT	50932	PS	Natural	62.4mm	1.8mm	1.3g	10 000 u.
	50877	PS	White				
	50918	PS	Black				9 000 u.



Natural - White
Naturel - Blanc



Custom colors
Couleurs spécifiques



Hot stamping
Marquage à chaud



Pad printing
Tampographie

ACCESSORIES



ANAÏS

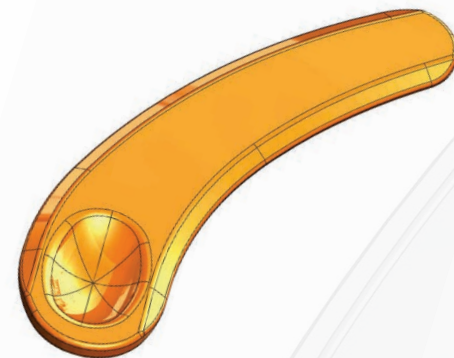

PRODUCT NAME	PRODUCT CODE	MATERIAL	COLOR	INDICATIVE LENGTH	INDICATIVE WIDTH	INDICATIVE WEIGHT	MOQ
Spatula ANAIS	51015	PS	Natural	62.4mm	1.9mm	1.4g	10 000 u.
	51016	PS	White				7 500 u.
	51000	PS	Black				



Natural - White
Naturel - Blanc



Custom colors
Couleurs spécifiques



Hot stamping
Marquage à chaud



Pad printing
Tampographie

ACCESSORIES



NINA

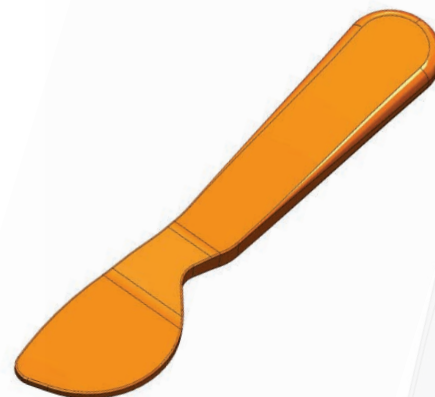

PRODUCT NAME	PRODUCT CODE	MATERIAL	COLOR	INDICATIVE LENGHT	INDICATIVE WIDTH	INDICATIVE WEIGHT	MOQ
Spatula NINA	50653	PS	White	62.4mm	3.5mm	1.3g	10 000 u.
	50630	PS	Black				6 000 u.



Natural - White
Naturel - Blanc



Custom colors
Couleurs spécifiques



Hot stamping
Marquage à chaud





Pad printing
Tampographie

ACCESSORIES

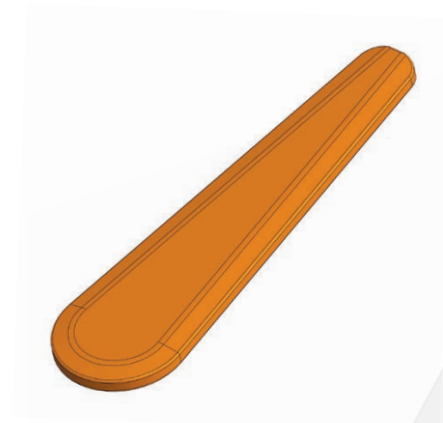

LILI



PRODUCT NAME	PRODUCT CODE	MATERIAL	COLOR	INDICATIVE LENGHT	INDICATIVE WIDTH	INDICATIVE WEIGHT
Spatula LILI	51112	PP	Natural	45mm	1.8mm	0.7g
	51113	PP	White			
 Spatula LILI-R	51114	recycled PP	Black	45mm	1.8mm	0.7g



Natural - White
Naturel - Blanc



Custom colors
Couleurs spécifiques



Hot stamping
Marquage à chaud



Pad printing
Tampographie

Minimum Order Quantity (MOQ): 10 000 units

ACCESSORIES



OLGA



PRODUCT NAME	PRODUCT CODE	MATERIAL	COLOR	INDICATIVE LENGTH	INDICATIVE WIDTH	INDICATIVE WEIGHT	MOQ
Spatula OLGA	51068	PS	Natural	62.7mm	1.9mm	1.2g	10 000 u.
	51069	PS	White				9 000 u.
	51070	PS	Black				



Natural - White
Naturel - Blanc



Custom colors
Couleurs spécifiques



Hot stamping
Marquage à chaud



Pad printing
Tampographie

ACCESSORIES

LEA

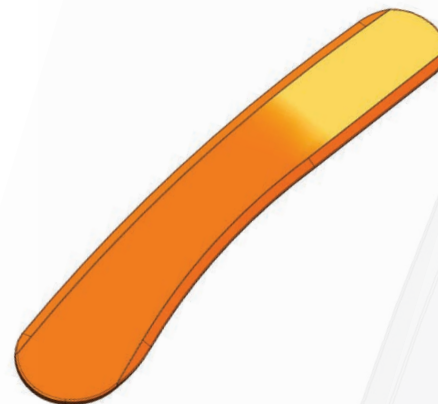

PRODUCT NAME	PRODUCT CODE	MATERIAL	COLOR	INDICATIVE LENGHT	INDICATIVE WIDTH	INDICATIVE WEIGHT
Spatula LEA	50227	PS	Natural	122.5mm	1.8mm	4g
	50405	PS	White			
	50570	PS	Black			
	50532	PP	Natural	120.9mm	1.75mm	3.3g
	50862	LDPE	Natural	120.5mm		3.4g
 Spatula LEA-R	51078	recycled PP	Black	120.9mm	1.75mm	3.3g



Natural - White
Naturel - Blanc



Custom colors
Couleurs spécifiques



Hot stamping
Marquage à chaud



Pad printing
Tampographie

Minimum Order Quantity (MOQ): 12000 units

ACCESSORIES

LOV'DEPIL®

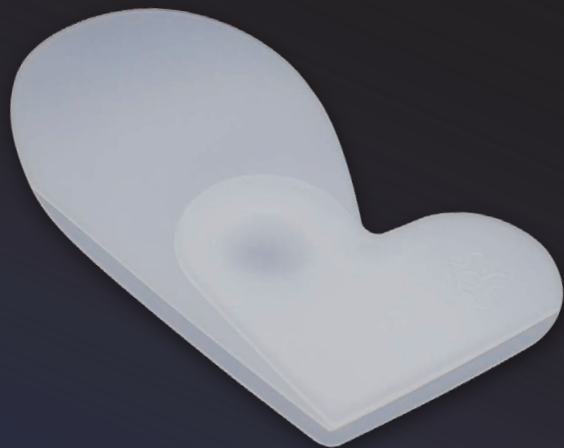
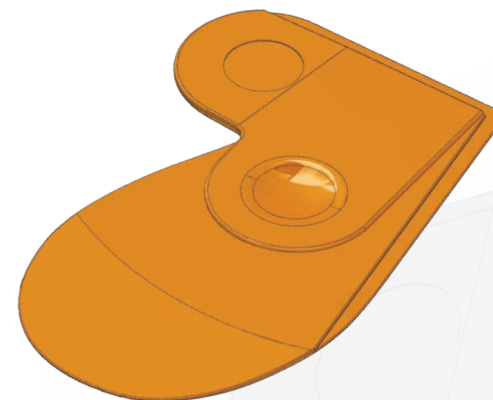

PRODUCT NAME	PRODUCT CODE	MATERIAL	COLOR	INDICATIVE LENGTH	INDICATIVE WIDTH	INDICATIVE WEIGHT	MOQ
Spatula LOV'DEPIL®	51011	HDPE	Natural	89mm	49mm	3.7g	10 000 u.
	51008	HDPE	White				
	51009	HDPE	Blue				48 000 u.
	51010	HDPE	Pink				

Logo engraving on request.
Gravure logo sur demande.



Natural - White
Naturel - Blanc



Custom colors
Couleurs spécifiques



Hot stamping
Marquage à chaud



Pad printing
Tampographie

ACCESSORIES



SPA

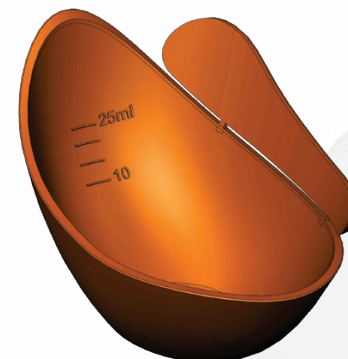

PRODUCT NAME	PRODUCT CODE	MATERIAL	COLOR	INDICATIVE WEIGHT	MOQ
Bowl SPA 25ml	50604	PS	Natural	8.9g	1 296 u.
Bowl SPA 25ml	50515		White		1 296 u.
Bowl SPA 250ml	50560		White	41.0g	1 080 u.
Bowl SPA 250ml	50631		Black		1 080 u.
Bowl SPA 500ml	50561		White	65.6g	1 050 u.



Natural - White
Naturel - Blanc



Custom colors
Couleurs spécifiques



Hot stamping
Marquage à chaud



Pad printing
Tampographie

ACCESSORIES

LUNA



PRODUCT NAME	PRODUCT CODE	MATERIAL	COLOR	INDICATIVE LENGHT	INDICATIVE WEIGHT
Spoon LUNA 5ml	50499	PP	Natural	74mm	1.6g
	50828	PP	White		
	50829	PP	Black		



Natural - White
Naturel - Blanc



Custom colors
Couleurs spécifiques



Hot stamping
Marquage à chaud



Pad printing
Tampographie

Minimum Order Quantity (MOQ): 12 000 units

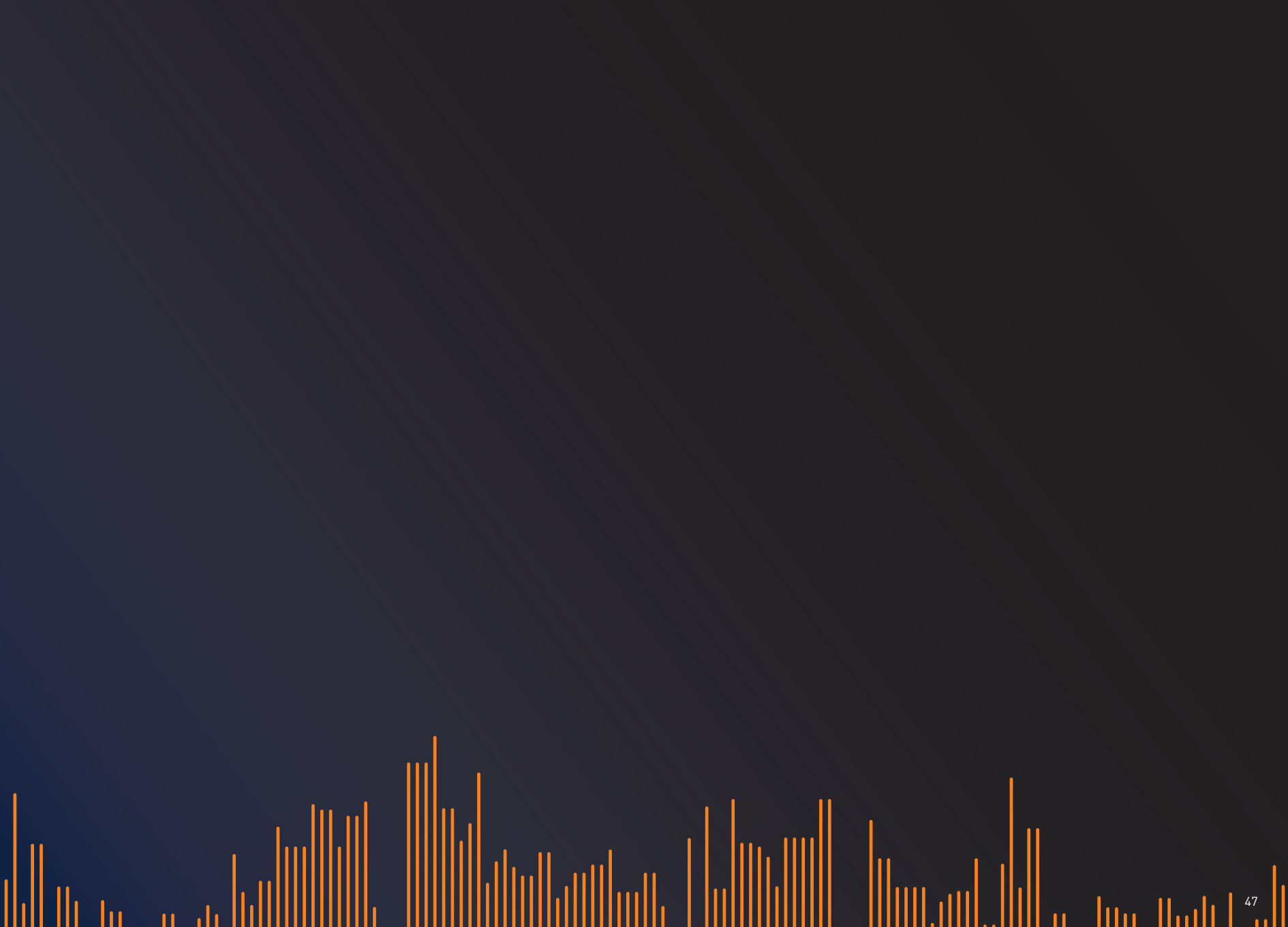

HEALTH

PHARMACEUTICAL
PACKAGINGS

MEDICAL
DEVICES

DIAGNOSTIC
DISPOSABLES



PHARMACEUTICAL PACKAGINGS



PRIMARY VIALS SYSTEM® Pharma

The Primary Vials system is a **dual mixing system specially developed for the pharmaceutical market.**

This allows to mix active powder or freeze-dried ingredients together with a solution, just before the application. This system is used in the medical field for ophthalmic and dermatological applications.

Le système Primary Vials est **un système de reconstitution développé pour le marché pharmaceutique.**

Celui-ci permet de mélanger des actifs en poudre ou lyophilisats avec une solution, juste avant l'application. Ce système est utilisé dans le médical pour des applications ophtalmiques et dermatologiques.



PRODUCT NAME	COLOR	MATERIAL	CAPACITY	INDICATIVE WEIGHT
Vial PRIMARY	Clear	Drawn Glass Type I	12ml	15.45g
Rubber Stopper/ Foil PRIMARY	White	ALU/TPE pharma grade	-	1.4g
Snap Ring PRIMARY	White	HDPE pharma grade	-	3.15g
Protective Cap PRIMARY	Natural White	PP pharma grade	-	0.5g
Nozzle CORALIGNE®	Natural White	LDPE pharma grade	-	0.65g
Cap CORALIGNE® Screw	Natural White	PP pharma grade	-	1.15g
Bottle CORALIGNE®	Natural White	LDPE MDPE pharma grade	7ml 12ml	2.5g 2.9g

Minimum Order Quantity (MOQ): 10 000 units

PHARMACEUTICAL PACKAGINGS



STERI-DOCK™

STERI-DOCK™ is a brand new dual mixing system specially developed for the Ophthalmic and ENT (Ear, Nose, Throat) markets.

This allows to mix active powder or freeze-dried ingredients just before application, combining a high protection of the ingredients through temper evident features. This system responds to the most demanding organisms of certification.

STERI-DOCK™ dispenses a drop of 40 microliters.

STERI-DOCK™ est un tout nouveau système pour mélange extemporané spécialement développé pour les marchés ophtalmique et ORL (oreille, nez, gorge).

Il permet de mélanger des ingrédients actifs en poudre ou lyophilisés juste avant l'application. Ce système est protégé par des témoins de première ouverture. Ce système répond aux organismes de certification les plus exigeants.

STERI-DOCK™ délivre une goutte de 40 microlitres.

PRODUCT NAME	COLOR	MATERIAL	CAPACITY	INDICATIVE WEIGHT
Vial STERI-DOCK™	Clear	Drawn Glass Type I	12ml	15.45g
Rubber Stopper / Foil PRIMARY	White	ALU/TPE pharma grade	-	1.4g
Screw Ring STERI-DOCK™	White	HDPE pharma grade	-	3.15g
Cap STERI-DOCK™	White	HDPE or PP pharma grade	-	1.6g
Nozzle CORALIGNE®	Natural White	LDPE pharma grade	40µl	0.65g
Cap CORALIGNE® Screw	Natural White	PP pharma grade	-	1.15g
Bottle CORALIGNE®	Natural White	LDPE MDPE pharma grade	7ml 12ml	2.5g 2.9g

On request

STERI-DOCK™ is patented by CORADIN SAS and a registered trademark of ORACLINICAL Inc. STERI-DOCK™ est breveté par CORADIN SAS et une marque déposée par ORACLINICAL Inc.

PHARMACEUTICAL PACKAGINGS



CORADOSE® Pharma

CORADOSE® is a plastic ampoule, closed by a repositionable stopper, with safety assured by a tamper evident ring.

CORADOSE® is a simple and efficient single-dose solution, an excellent alternative to breakable glass vials.

CORADOSE® est une ampoule plastique, fiable grâce à sa bague d'inviolabilité, et qui est fermée par un bouchon repositionnable. C'est une excellente alternative aux ampoules verre cassantes et coupantes.

CORADOSE® est une solution mono-dose simple et efficace.

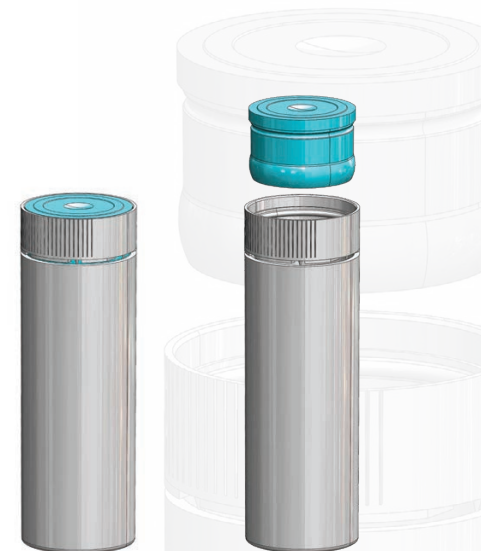

PRODUCT NAME	PRODUCT CODE	COLOR	NECK	MATERIAL	CAPACITY	WEIGHT
Barrel CORADOSE® Pharma	50869 50870	White Blue	19.45mm	PP	10ml	3.2g
Cap CORADOSE® Pharma	50871	White	-	LDPE	-	1.1g

Minimum Order Quantity (MOQ): 10 000 units

PHARMACEUTICAL PACKAGINGS



CORALIGNE® Pharma

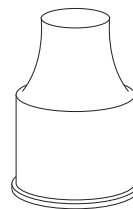

PRODUCT NAME	COLOR	MATERIAL	CAPACITY	WEIGHT
Bottle CORALIGNE® Pharma	Natural White	MDPE	12ml	2.9 g
Cap CORALIGNE® Pharma Screw	White	PP	-	1.15g
Nozzle CORALIGNE® Pharma	Natural White	LDPE	-	0.65g

Minimum Order Quantity (MOQ): 10 000 units

PHARMACEUTICAL PACKAGINGS



PAC Pharma

Screwed to the bottle, our 24/410 cuttable tip enables the precise application of products.

Vissée sur un flacon, notre pointe à couper 24/410 permet la distribution ciblée de produits.



PRODUCT NAME	NECK	MATERIAL	COLOR	WEIGHT
Cap/Cuttable tip PAC 24/410 Screw Pharma	GCM1 24/410	LDPE pharma grade	White	3.2g

Minimum Order Quantity (MOQ): 48 000 units

PHARMACEUTICAL PACKAGINGS

CALIC® Pharma

CALIC® is a single unit snap-on cap, click-fit, tamper evident (protected by a tear away plastic pellet).

La capsule CALIC est une capsule monobloc, encliquetable, à levier inviolable (protection par une pastille déchirable).

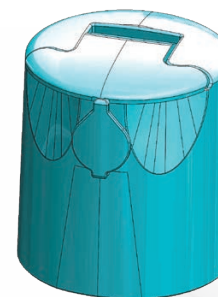

PRODUCT NAME	NECK	MATERIAL	COLOR	ORIFICE DIAMETER
Cap CALIC® Snap-on Pharma	27.5 mm	HDPE Pharma grade	White	Ø1.5 mm (1.7 mm ²)
			Natural	Ø1.5 mm (1.7 mm ²)
			Natural	Ø 3 mm (7 mm ²)
			White	Ø 3 mm (7 mm ²)

Minimum Order Quantity (MOQ): 48 000 units

PHARMACEUTICAL PACKAGINGS

TDC Pharma

Our **eye dropper heads** (40µl or 50µl) are **adaptable to glass vials, ampoules and other containers.**

They find applications on the ophthalmic (on request) and veterinary markets.

Our dropper heads are manufactured in ISO 5 clean room environment, and can be blistered and sterilized.

CE labelling on request (human health).

Nos **têtes compte-gouttes** (40µl ou 50µl) sont **adaptables sur des flacons en verre, ampoules et autres contenants.**

Elles trouvent leurs applications sur les marchés ophtalmiques (sur demande) et vétérinaires.

Nos têtes compte-gouttes sont fabriquées dans une salle blanche ISO 5 et peuvent être mises sous blister et stérilisées.

Marquage CE sur demande (santé humaine).



PRODUCT NAME	NECK	MATERIAL	COLOR OF CAP	DROP SIZE	CHARACTERISTICS
Cap/Eye Dropper TDC	22.4mm	PVC/PP	Red/ Natural	40 µl	Blister Sterilized
Cap/Eye Dropper TDC	22.4mm	PVC/PP	White/Natural	50 µl	Blister Sterilized

Minimum Order Quantity (MOQ): 52 500 units

Set of spatulas CORAMED

A set of disposable spatulas for medical use such as the application of antifungal drugs (Amorolfine). These spatulas can be sterilized and have received the CE marking (Class I).

Le set de spatules jetables est un dispositif médical destiné à l'application de soin médicamenteux de type antifongique (Amorolfine). Il peut être stérilisé et bénéficie d'un marquage CE (Classe I).



PRODUCT NAME	PRODUCT CODE	MATERIAL	COLOR	WEIGHT	CHARACTERISTICS
Set of spatulas CORAMED	50678	LDPE Pharma grade	Natural	6.2 g	10 units
Set of spatulas CORAMED	50868	HDPE Pharma grade	Natural	6.2 g	

Minimum Order Quantity (MOQ): 70 000 units

MEDICAL DEVICES

SPECIFIC DEVELOPMENT

CORADIN develops **specific medical devices** that find applications in pharmaceutical fields such as allergy testing, control of sleep apnoea...

Parts are injected in ISO 8 or ISO 5 clean environment and can be blistered, sterilized on request.

CORADIN développe des **dispositifs médicaux spécifiques** qui trouvent des applications dans les domaines pharmaceutiques telles que les tests d'allergie, le contrôle de l'apnée du sommeil...

Les pièces sont injectées dans un environnement propre ISO 8 ou ISO 5 et peuvent être blistérées et stérilisées sur demande.

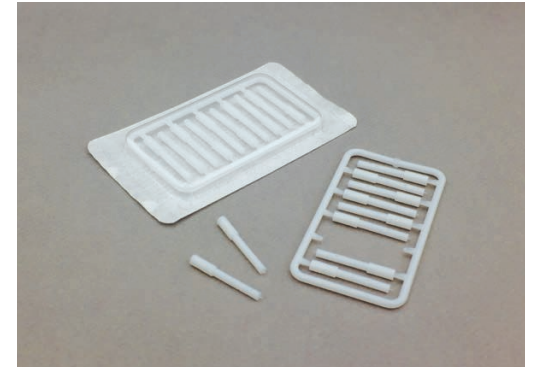

DIAGNOSTIC DISPOSABLES



SPECIFIC DEVELOPMENT

CORADIN is a leader in developing and manufacturing specific challenging diagnostic parts and disposables.

Through our expertise in one-material and bi-injection molding we provide our clients reliable advises in the development of performing diagnostic products, which are then qualified and produced in our workshop in clean environment.

CORADIN est un leader dans le développement de pièces techniques et consommables diagnostics.

Grâce à notre expertise dans le moulage d'un matériau et en bi-injection, nous assistons nos clients dans le développement de produits de diagnostic performants, qui sont ensuite qualifiés et fabriqués dans notre atelier en environnement propre.





CORADIN SAS | Parc d'Activité de l'Argile VI - Lot 620
440, avenue de la Quiéra - 06370 Mouans-Sartoux - France
T +33 (0)4 92 28 80 00 | contact@coradin.com
www.coradin.com

 CORADIN
plastic injection molding

Cat 02 / Mai 2019

Création Arcanes Communication © www.arcanes.fr | Imprimé sur papier issu de forêts gérées durablement.

